



Type 31-160165.

**Pladevarmeveksler model U165R i 316L.
 Til bassin størrelser 10 - 150m³.
 Pakning materiale NBR.**

Duty:			
Company:	Welldana	Item No:	
	108 m3		
PHE Type:	U2	Engineer:	RBI
Quotation No:		Date:	2011.Dec.02 13.57

Process Data	Hot	Batch
Fluid	WATER	WATER
Overall Fluid Volume	l	108000,0
Mass Flow Rate	kg/h	3401
Volume Flow Rate	l/h	3500
Inlet / Starting Temperature	°C	80,000
Outlet/Ending Temperature, Duty	°C	28,000
Heating / Cooling Time Needed	min	1440,00
Pressure Drop, calculated	bar	0,18
Heat Exchange Rate, Duty	kW	104,30
Design (Duty) HTC	W/°C m ²	2614,3
Clean HTC	W/°C m ²	6900,4
% Difference in HTC		164,0%
Fluid Volume in PHE	l	0,8
		0,8

Fluid Properties	Hot	Cold
Density	kg/(m ³)	979,6
Specific Heat Capacity	kJ/kg °C	4,185
Thermal Conductivity	W/m °C	0,659
Inlet Viscosity	mPa s	0,36
Outlet Viscosity	mPa s	0,51

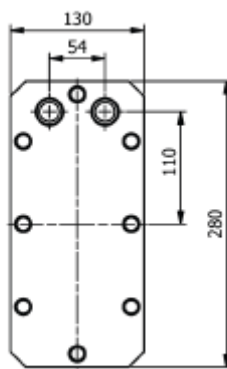
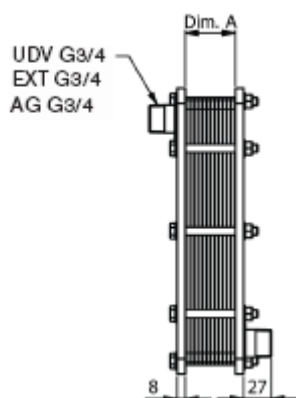

Tilslutninger			Beskrivelse
Fig.	Pos.	Dimension	
1	H1	R 3/4 Rørgvind (Udv.) SS 304 ISO 7/1	VAND (Varm) tilgang
1	F4	R 3/4 Rørgvind (Udv.) SS 304 ISO 7/1	VAND (Varm) afgang
1	F3	R 3/4 Rørgvind (Udv.) SS 304 ISO 7/1	VAND (Kold) tilgang
1	H2	R 3/4 Rørgvind (Udv.) SS 304 ISO 7/1	VAND (Kold) afgang

U1

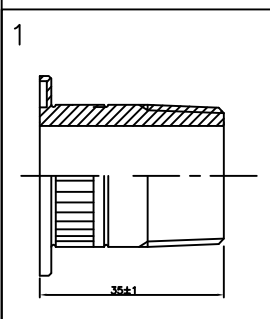
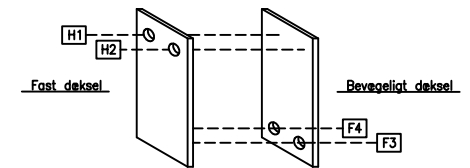
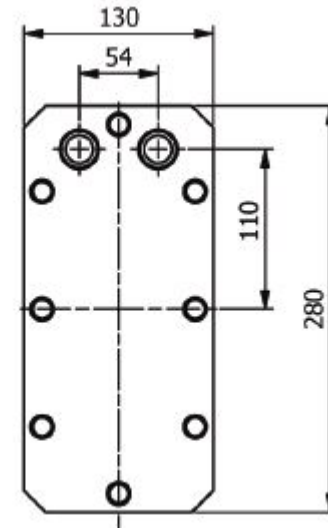
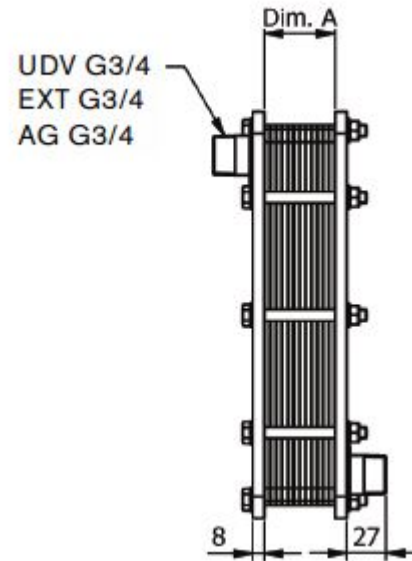

8 Platinvej
Kolding, Denmark
Tel.: 4570278444
Fax: 4570278445

APV®

Vægt kg: 11
Tegnet af:
Kontrolleret af:
Godkendt af:
TGH0V02 Ikke i målestok
Arkiv

Komplet PW type U165R

Uncontrolled Copy

Design tryk.:
Basis nr.:

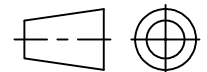

Tegnings Nr.: Rev.