

AQUADECK®

POOLCOVERS

Installation instructions

Fixed flap in bottom

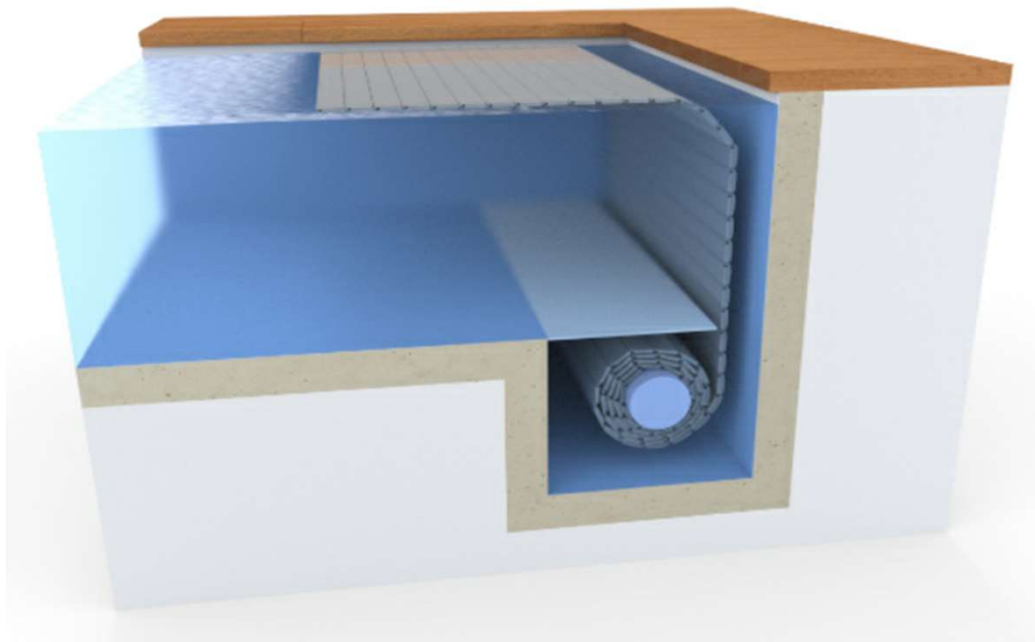







Close _____
to be **perfect**

AQUADECK®

POOLCOVERS

Tools required for assembly:

Not included:

Impact drill	
Tape measure	
Marker/Pencil	
Perforating punch 8 mm	
Sealant gun	
Hammer	
Ring wrench 2x (19/17/13 mm)	
Allen key 4/5/6 mm	
Stone drill 12/11/6 mm	

Close _____
to be **perfect**

Assembly fixed flap

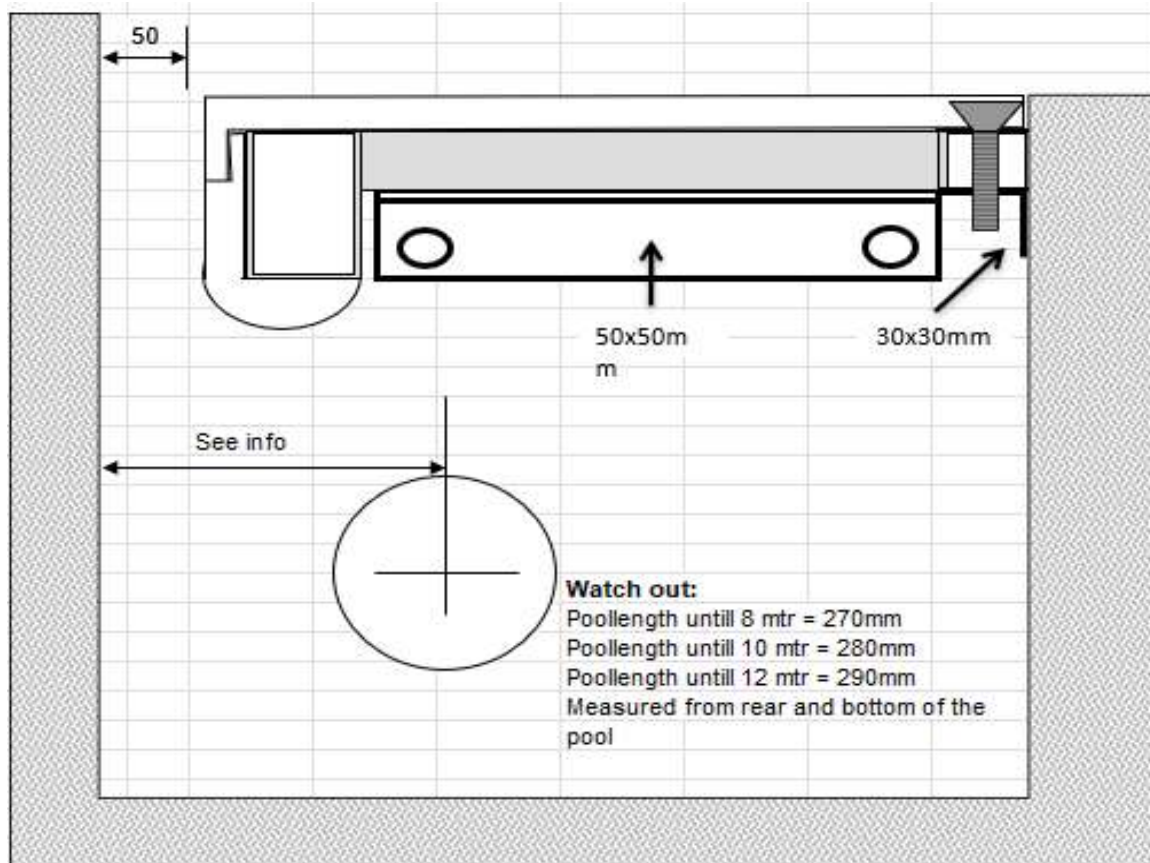

- 1 Assemble profile 30x30 mm
- 2 Assemble profile 50x50 mm against the profiles 30x30 mm
- 3 Put flap on the profiles and take over the holes
- 4 Remove flap
- 5 Bore the profile (bore and tap are included)
- 6 Put flap back on and fix it with bold M8x60

Watch out:

Check if the motor is turning in the right direction when pushed open before fixing the flap
Tape the straps with tape on the back side of the pool

Watch out !!

When you make tiles on the plates:

- Don't mount tiles outside the PVC plate.
- Never grind into the PVC plate.

